

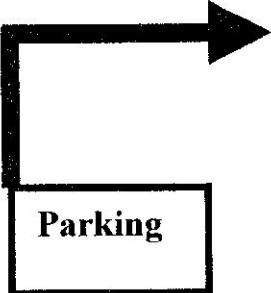

**5ème balade des Blouses Blanches**  
 dimanche 06 avril 2003  
 Voiture balai Charles FOUARGE : 0497 / 87 29 89

**1**

<p>2</p>  <p>Parking</p> <p>000 m.                      000 m.</p>	<p>6</p>  <p>ENSIVAL 7</p> <p>1,100                      4,500</p>	<p>10</p>  <p>900 m.                      9,500</p>
<p>1</p>  <p>GARE                      Parking</p>	<p>5</p>  <p>Xhendelesse 2</p> <p>2,100                      3,400</p>	<p>9</p>  <p>CORNESSE</p> <p>1,400                      8,600</p>
<p><b>Départ:</b>      face au café      « The Paradise »      ancienne gare de      HERVE</p>	<p>4</p>  <p>Soumagne 4</p> <p>500m.                      1,300</p>	<p>8</p>  <p>n° 84</p> <p>route des Sources</p> <p>1,300                      7,200</p>
<p><b>Bienvenue à notre</b>      5ème balade des Blouses      Blanches organisée au      profit de la      Court'Echelle      par le HERVE MOTO      RETRO CLUB</p>	<p>3</p>  <p>Soumagne Bas</p> <p>800 m.                      800m.</p>	<p>7</p>  <p>SOIRON</p> <p>1,400                      5,900</p>

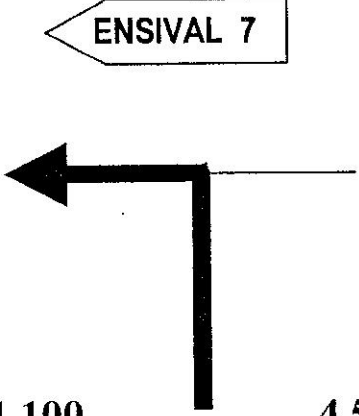
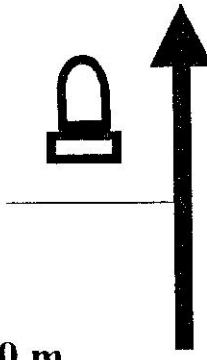
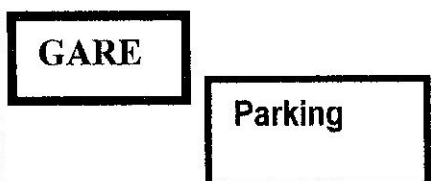
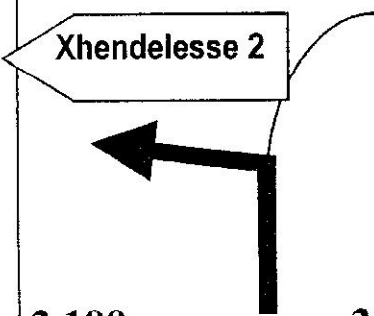
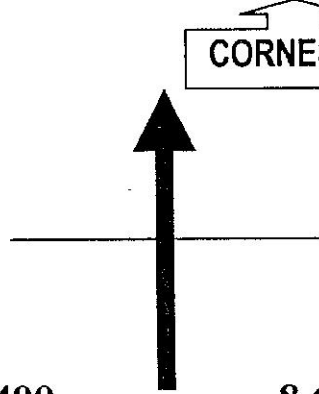
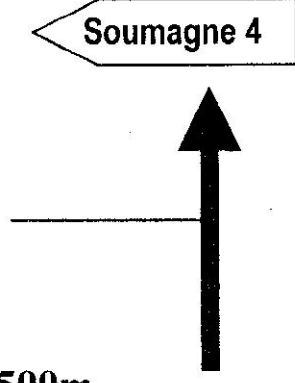
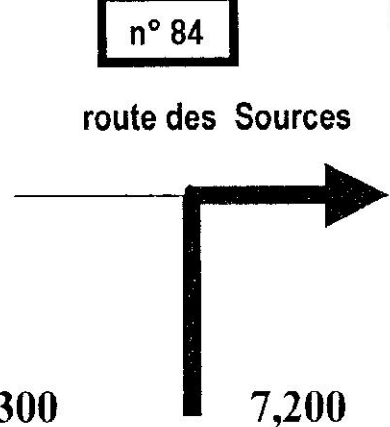
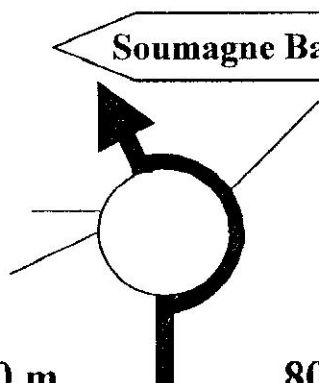
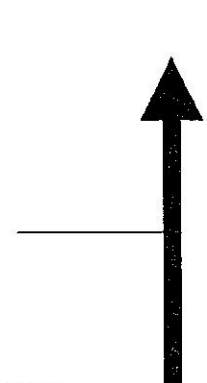

# 5 ème balade des Blouses Blanches

dimanche 06 avril 2003

# 2

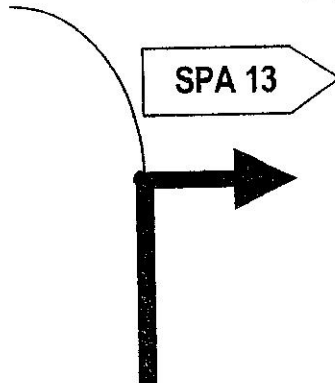
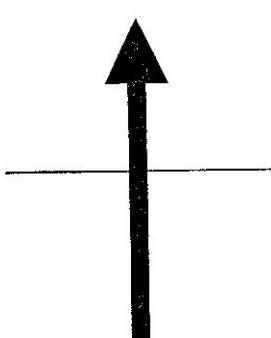
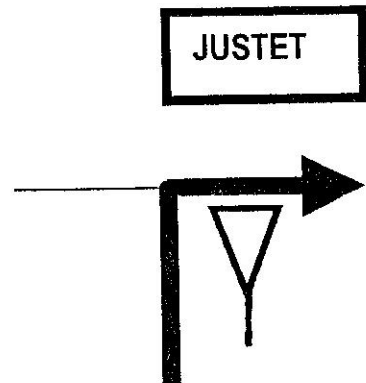
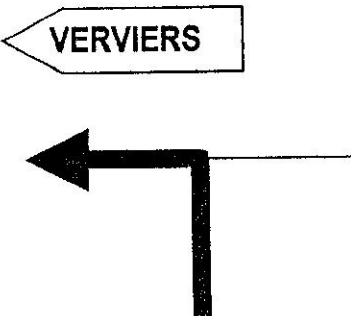
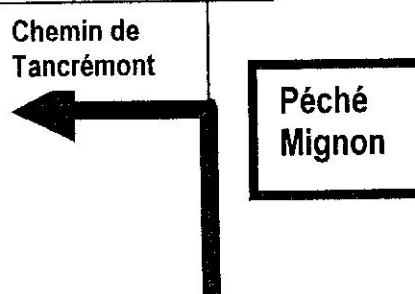
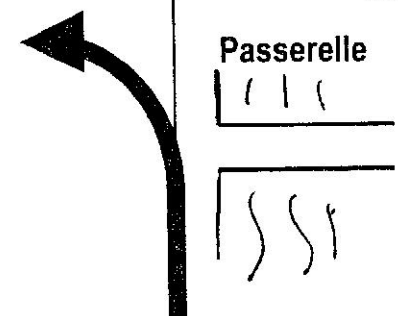
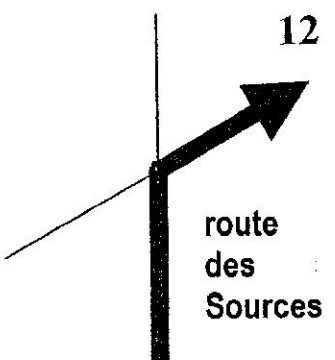
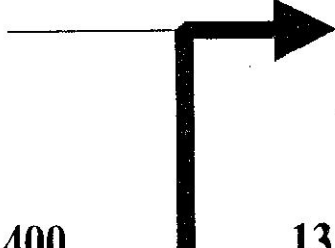
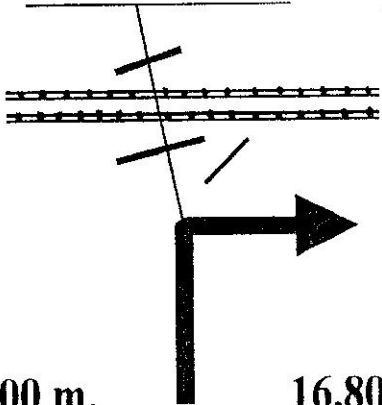
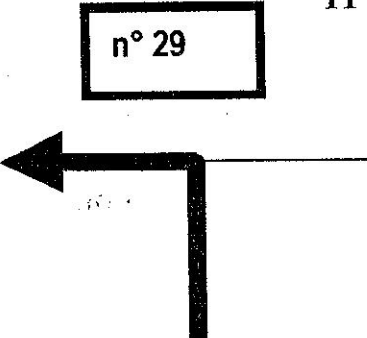
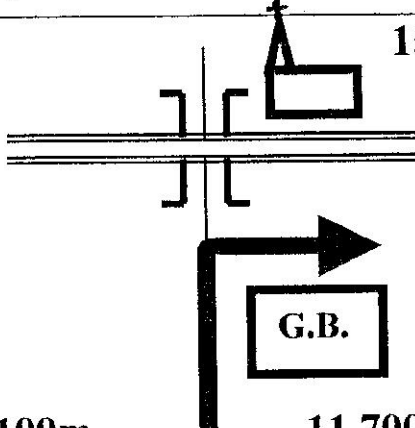
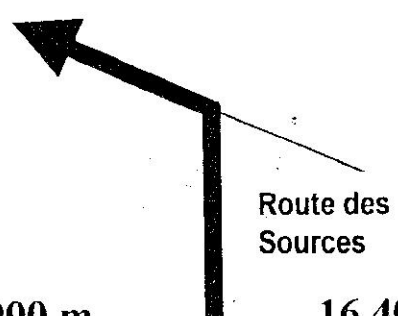
<p>14</p>  <p>300m. 11,600</p>	<p>18</p>  <p>1,000 15,500</p>	<p>22</p>  <p>200 m. 17,800</p>
<p>13</p>  <p>700m. 11,300</p>	<p>17</p>  <p>1,400 14,500</p>	<p>21</p>  <p>800 m. 17,600</p>
<p>12</p>  <p>800 m. 10,600</p>	<p>16</p>  <p>1,400 13,100</p>	<p>20</p>  <p>400 m. 16,800</p>
<p>11</p>  <p>300 m. 9,800</p>	<p>15</p>  <p>100m. 11,700</p>	<p>19</p>  <p>900 m. 16,400</p>



**5 ème balade des Blouses Blanches**  
dimanche 06 avril 2003

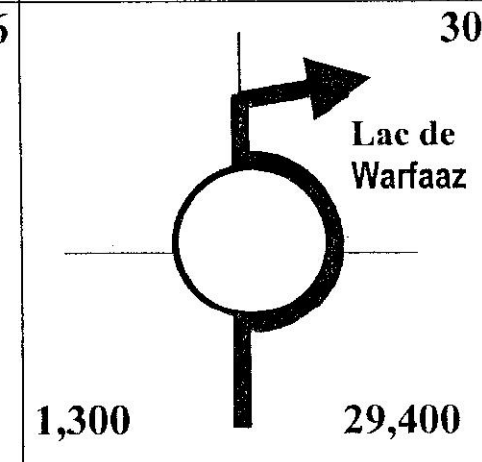
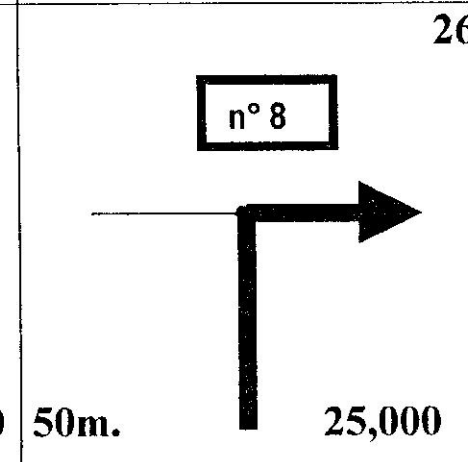
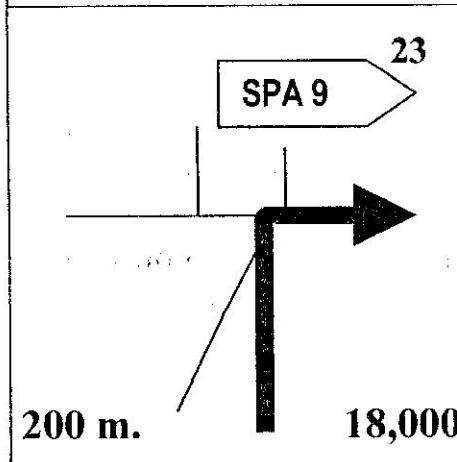
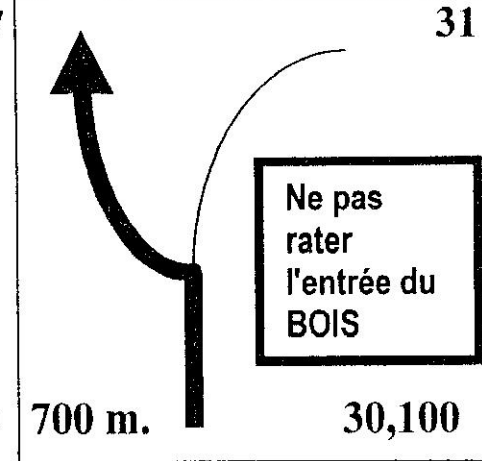
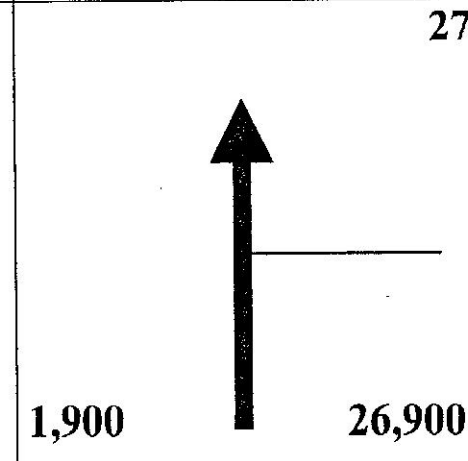
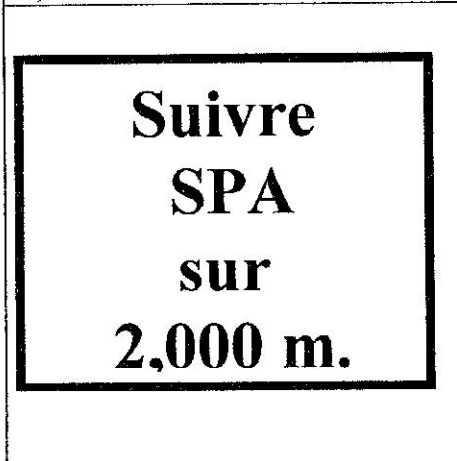
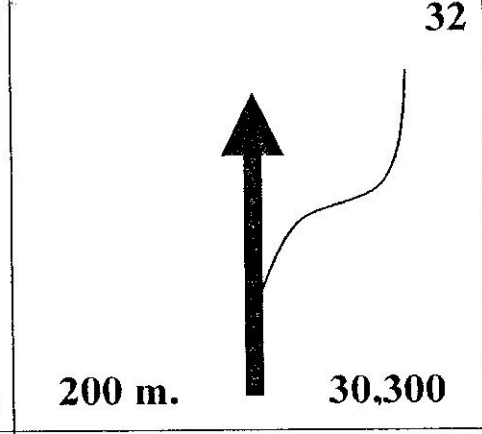
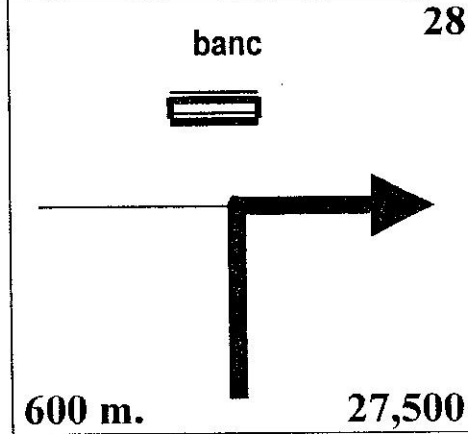
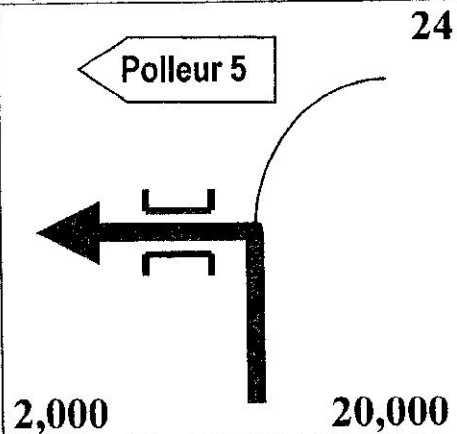
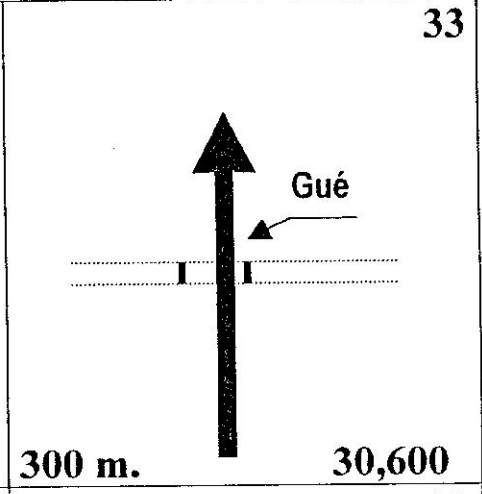
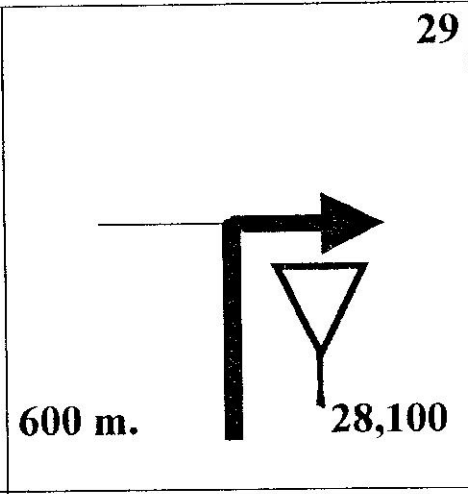
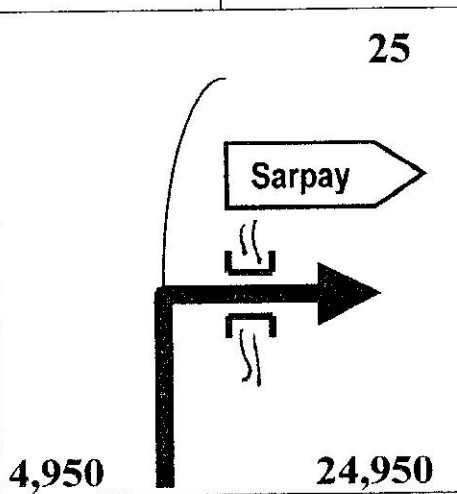

**3**



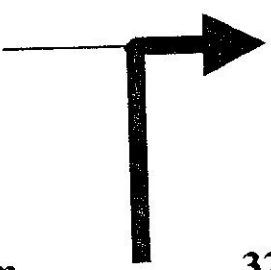
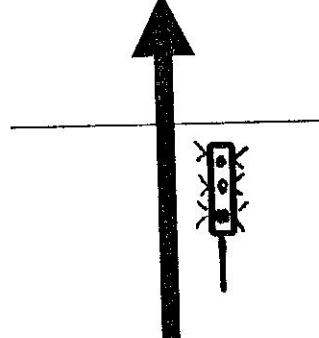

**5ème balade des Blouses Blanches**  
dimanche 06 avril 2003

**4**

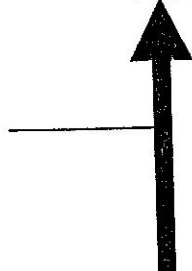
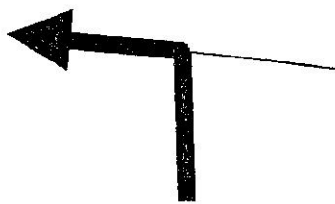
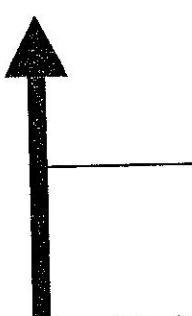
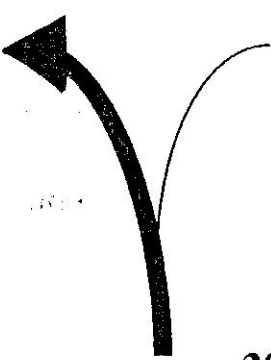
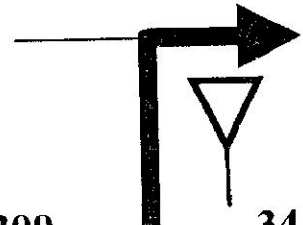
<p>37</p> <p>Wayai</p>  <p>900m. 32,500</p>	<p>40</p>  <p>7,200 47,600</p>	<p>44</p> <p>Wanne 6</p>  <p>Ambève</p> <p>200 m. 400 m.</p>
<p>36</p> <p>Auberge du Wayai</p>  <p>200m. 31,600</p>	<p>39</p> <p>STAVELOT 5</p>  <p>5,600 40,400</p>	<p>43</p> <p>rue Gustave DEWALQUE</p>  <p>200 m. 200 m.</p>
<p>35</p>  <p>600 m. 31,400</p>	<p><b>R. S. P.</b> <b>STAVELOT</b> <b>5,600 m.</b></p>	<p>42</p> <p>Compteur à zéro Départ prendre la direction de REFAT/ WANNE</p> <p>0,000 0,000</p>
<p>34</p>  <p>200 m. 30,800</p>	<p>38</p> <p>STAVELOT</p>  <p>2,300 34,800</p>	<p>41</p> <p>Arrêt GRAISSAGE STAVELOT</p> <p>200 m. 47,800</p>



**5 ème balade des Blouses Blanches**  
dimanche 06 avril 2003

**5**

46

Grand Halleux

1,300 6,700

50

rue  
Capitaine  
Lekeux

900 m. 9,600

53

SART 2

3,200 18,900

**R. S. P.**  
**VIELSAM**  
1,300 m.

49

400 m. 8,700

52

LIERNEUX 8

800 m. 15,700

45

VIELSAM

5,000 5,400

48

Le Cabanon

1,100 8,300

51

LIERNEUX 9

5,300 14,900

**R. S. P.**  
**WANNE**  
5,000 m.

47

500m. 7,200

**R. S. P.**  
5,300 m.



# 5ème balade des Blouses Blanches

dimanche 06 avril 2003

6

Arrêt repas de midi  
libre choix,  
restaurant ou  
pique-nique.  
Bon appétit

8,600

31,000

100 m.

59

LIERNEUX

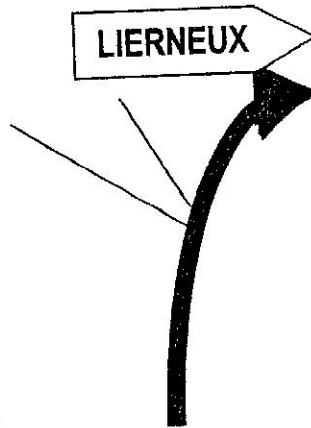

6,100

1,900

63

HIERLOT 1

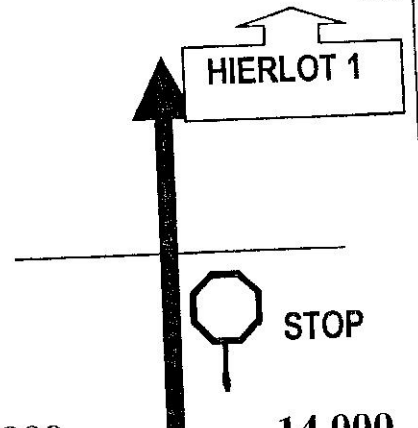

14,000

R. S. P.

8,600 m.

Ferme St Martin



58

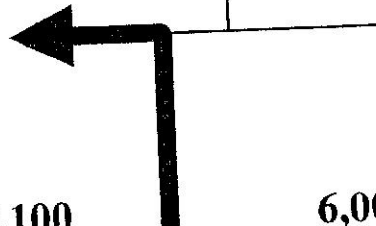

2,100

6,000

62

LANSIVAL 1

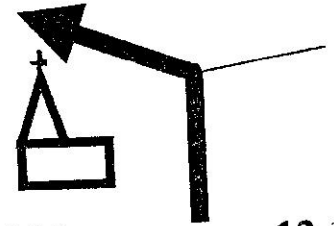

300 m.

12,100

Baraque Fraiture

55

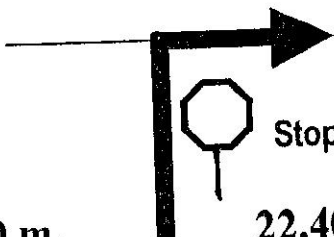

800 m.

22,400

3,900

57

Malempré 3

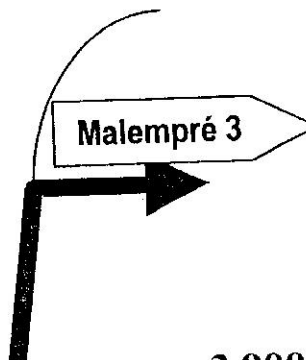

3,900

2,700

61

LIERNEUX 3

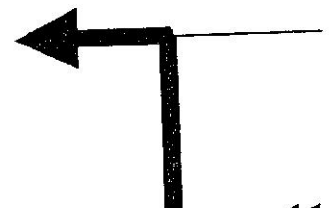

11,800

1 JOUBIEVAL

54



2,700

21,600

0,000

56

MANHAY 8

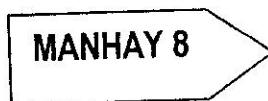

0,000

3,000

60

LIERNEUX 6



9,100



**5ème balade des Blouses Blanches**  
dimanche 06 avril 2003

**7**

67

TROIS PONTS 4

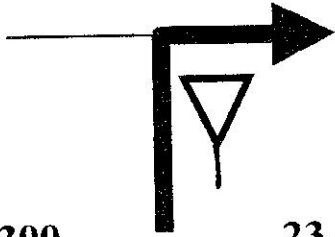

2,300

23,800

**R. S. P.**  
**Francorchamps**  
**4,900 m.**

72

SPA



3,100

47,300

66

Basse-Bodeux 2

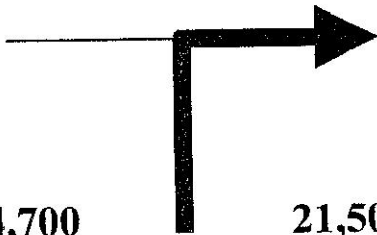

4,700

21,500

Francorchamps

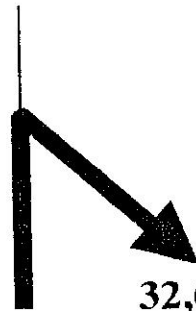

8,800

32,600

68

CREPPE

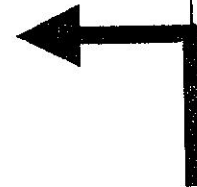

2,800

44,200

71

65

Basse-Bodeux 7

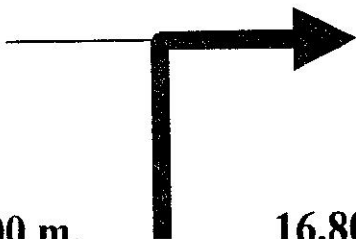

200 m.

16,800

„  
**Station AVIA** „  
d'essences au  
km. 25,800

70

SPA

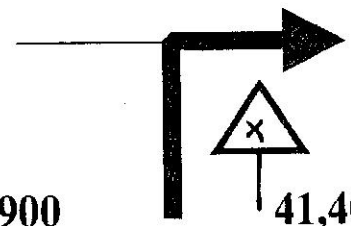

3,900

41,400

Basse-Bodeux 7

64

Domaine  
des  
Sources



2,600

16,600

**R. S. P.**  
**vers COO**  
**8,800 m.**

69

SPA

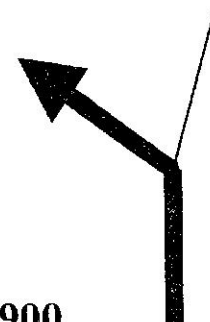





4,900

37,500

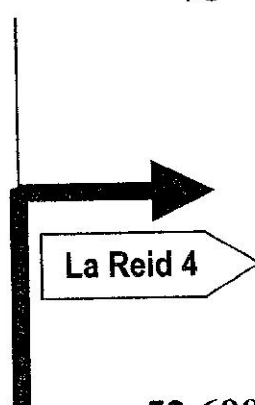
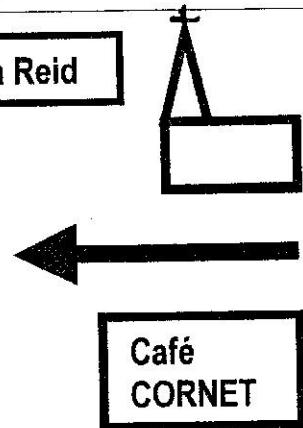
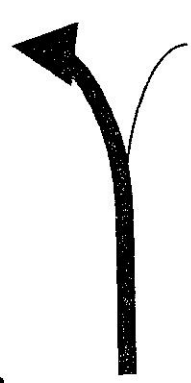
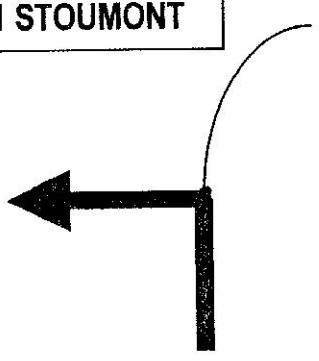

**5ème balade des Blouses Blanches**  
dimanche 06 avril 2003

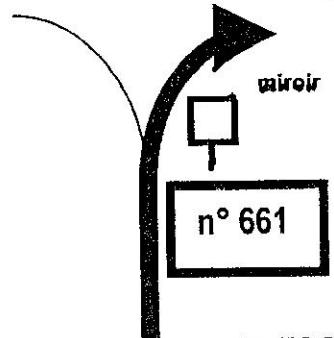
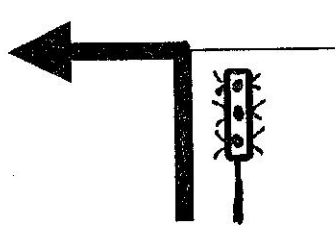
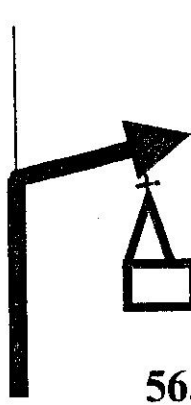
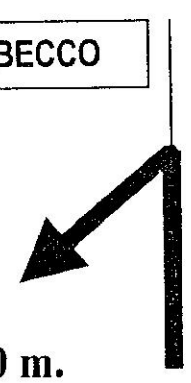
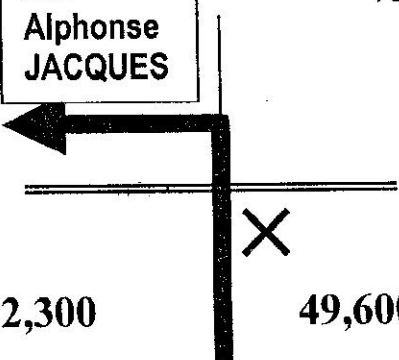
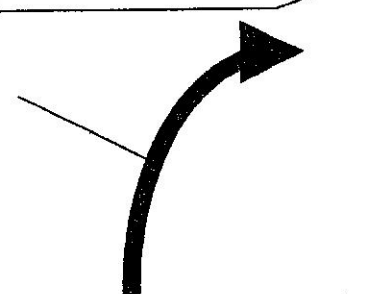
**8**

<p>76</p>  <p>500m. 52,600</p>	<p>La Reid</p>  <p>79</p> <p>0,000 0,000</p>	 <p>83</p> <p>300 m. 7,800</p>
<p>11 STOUMONT</p>  <p>75</p> <p>2,100 52,100</p>	 <p>100 m. 56,600</p>	 <p>82</p> <p>3,300 7,500</p>
 <p>74</p> <p>400 m. 50,000</p>	 <p>78</p> <p>1,400 56,500</p>	<p>BECCO</p>  <p>81</p> <p>800 m. 4,200</p>
<p>rue Alphonse JACQUES</p>  <p>73</p> <p>2,300 49,600</p>	<p>REMOUCHAMPS 5</p>  <p>77</p> <p>2,500 55,100</p>	<p>3 THEUX</p>  <p>80</p> <p>3,400 3,400</p>





# 5ème balade des Blouses Blanches

dimanche 06avril 2003

9

<p>87</p> <p>23 LIEGE</p> <p>2,600      12,500</p>	<p>91</p> <p>n° 1</p> <p>400 m.      17,700</p>	<p>95</p> <p>suivre SOUMAGNE</p> <p>SOUMAGNE 3</p> <p>1,900      25,900</p>
<p>86</p> <p>THEUX</p> <p>1,000      9,900</p>	<p>90</p> <p>FRAIPONT</p> <p>1,700      17,300</p>	<p>94</p> <p>SOUMAGNE 5</p> <p>1,100      24,000</p>
<p>85</p> <p>FERME n° 571</p> <p>1,000      8,900</p>	<p>89</p> <p>BANNEUX</p> <p>900 m.      15,600</p>	<p>93</p> <p>TARTERIE</p> <p>200 m.      22,900</p>
<p>84</p> <p>!!! route dégradée</p> <p>100 m.      7,800</p>	<p>88</p> <p>LIEGE</p> <p>2,200      14,700</p>	<p>92</p> <p>B.B.L</p> <p>5,000      22,700</p>



**5ème balade des Blouses Blanches**  
dimanche 06 avril 2003

**10**

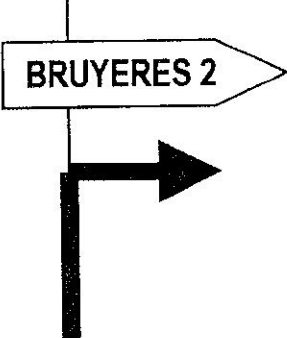
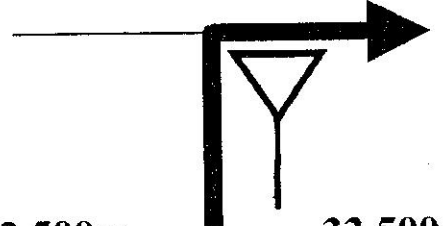
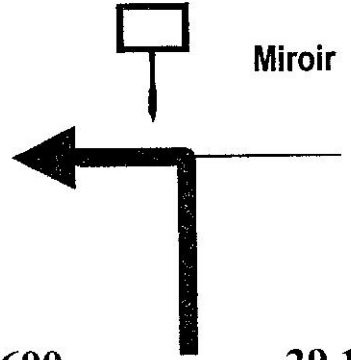
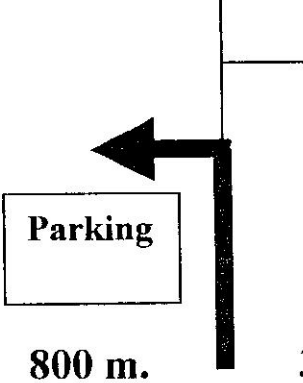
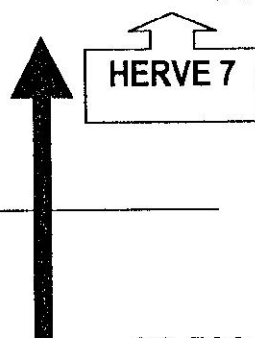
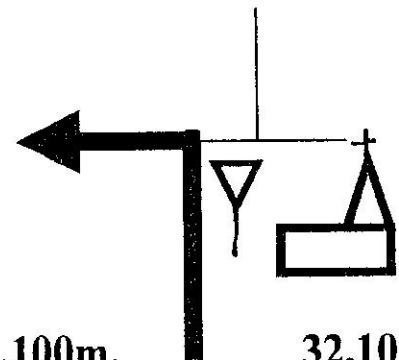
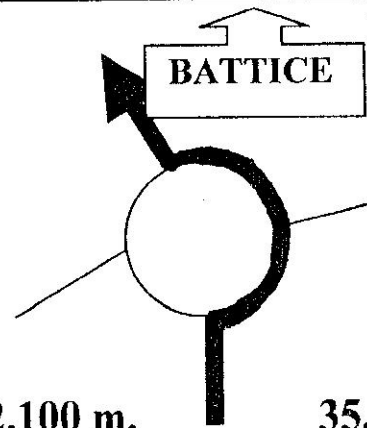
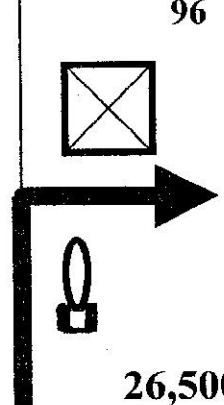
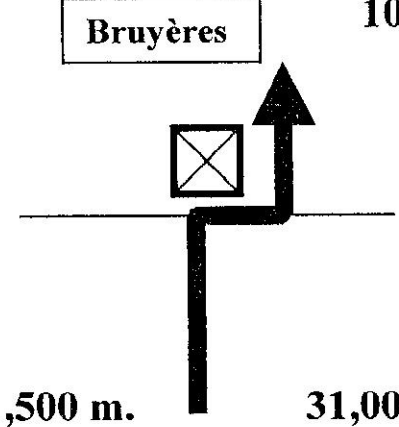
<p>99</p>  <p>400m. 29,100</p>	<p>103</p>  <p>2,500m. 33,500</p>	<p>107</p> <p><b>BRAVO</b></p> <p><b>VOUS Y</b></p> <p><b>ÊTES</b></p> <hr/>
<p>98</p>  <p>1,600 29,100</p>	<p>102</p> <p><b>R.S.P.</b> <b>sur 1,400m</b></p>	<p>106</p>  <p>800 m. 36,400</p>
<p>97</p>  <p>1,000 27,500</p>	<p>101</p>  <p>1,100m. 32,100</p>	<p>105</p>  <p>2,100 m. 35,600</p>
<p>96</p>  <p>600 m. 26,500</p>	<p>100</p>  <p>1,500 m. 31,000</p>	<p>104</p> <p><b>R.S.P.</b> <b>sur 2,100m</b></p>



**5ème balade des Blouses Blanches**  
dimanche 06 avril 2003

**11**

**Fin de la balade, merci de votre participation,  
bon retour et rendez-vous :**

**le 20 avril 2003 « 16ème Week-end des Hobbys (Pâques) » A**

**le 25 mai 2003 « Balade surprise » C**

**le 29 juin 2003 « Balade surprise » C**

**le 13 juillet 2003 « Balade surprise » C**

**le 20 juillet 2003 « 14<sup>ème</sup> Balade de l'Amitié » A**

**le 03 août 2003 « Fête à Cerexhe-Heuseux » motos A + C**

**le 10 août 2003 « Balade surprise » C**

**le 07 septembre 2003 « Balade à Moulan »**

**le 21 septembre 2003 « Coupe Contact » motos A + C**

**le 19 octobre 2003 « 11ème Scooters au Pays de Herve » S**

**le 22 novembre 2003 « Souper du Club »**